

Article number: 057153303404

Description: HEPCO GV3 bearing BHJ 34 E
Standard for Blind hole Fixing

Measures

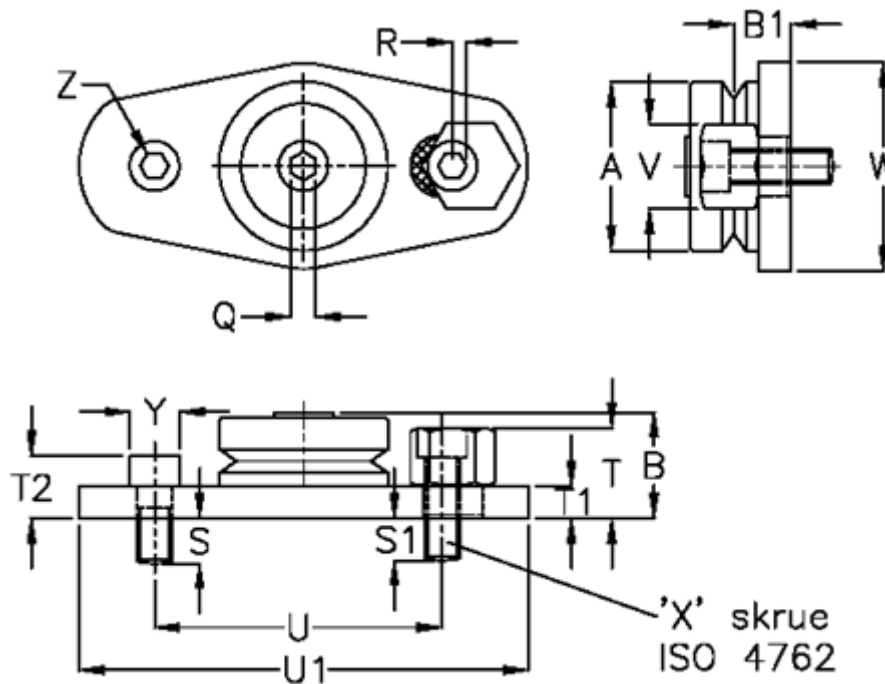

a = 34.0	T1 = 6.50	Y = 10.0
B = 21.3	T2 = 12.50	Z = 14
B1 = 11.50	U = 60.0	
Q = 4.0	U1 = 90.5	
R = 2.0	V = 17	
S = 9.50	W = 42.0	
S1 = 8.5	Weight kg/1000 = 0	
T = 17.5	X = M6	